



2021  
Juin-Décembre





## Encouragez la créativité avec les briques LEGO® !

Stimulez l'imagination et renforcez l'assurance des plus jeunes, tout en favorisant un apprentissage ludique. Motivez les enfants plus âgés en quête de constructions stimulantes, avec des histoires à inventer et des modèles détaillés. Offrez aux adultes une pause relaxante pour construire et exposer leurs passions. Avec les sets LEGO®, il y en a pour tout le monde - jetez un œil à l'intérieur !

### SE CONNECTER



**LEGO.com**  
Jeux, vidéos et plus



**Appli Catalogue 3D**  
Observer les modèles prendre vie



**LEGO.com/life/app**  
Partager ses créations



**youtube.com/LEGO**  
Vidéos et mini-films



**facebook.com/LEGO**  
Nouveautés, événements et activités



**instagram.com/LEGO**  
Idées et découverte des coulisses



**pinterest.com/LEGO**  
Idées et inspiration



**twitter.com/LEGO\_Group**  
Informations récentes

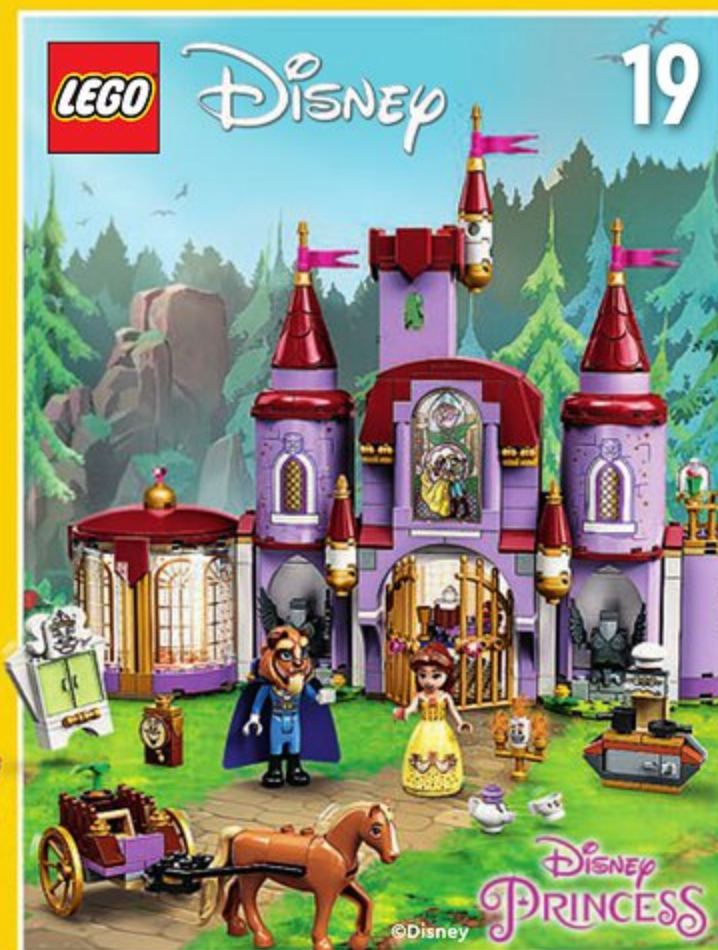



- 6 LEGO® DUPLO®
- 15 LEGO Classic
- 16 LEGO Creator
- 19 LEGO | Disney
- 21 LEGO Friends
- 30 LEGO DOTS
- 32 LEGO Super Mario™
- 35 LEGO VIDIYO™
- 38 LEGO City
- 47 LEGO Minifigures
- 48 LEGO Marvel Avengers
- 52 LEGO Marvel Spider-Man
- 54 LEGO DC Batman™
- 55 LEGO MINDSTORMS®
- 55 LEGO BOOST
- 56 LEGO NINJAGO®
- 62 LEGO Jurassic World
- 63 LEGO Speed Champions
- 64 LEGO Harry Potter™
- 68 LEGO Minecraft®
- 70 LEGO Star Wars™
- 76 LEGO Technic
- 83 LEGO sets pour adultes

De la part de :

# MA LISTE AU PÈRE NOËL

Référence  
LEGO

Nom du set

Classement

**NOUVEAUTÉS  
Septembre**

**24 cadeaux**



**76196**  
Le calendrier de  
l'Avent des Avengers  
A partir de 7 ans



**41690**  
LEGO® Friends Le  
calendrier de l'Avent  
A partir de 6 ans



**60303**  
Calendrier de  
l'Avent LEGO® City  
A partir de 5 ans



**76390**  
Le calendrier de  
l'Avent LEGO®  
Harry Potter™  
A partir de 7 ans

**RETROUVE TON  
CALENDRIER DE L'AVENT  
STAR WARS**

**PAGE 73 DU CATALOGUE**



WIZARDING WORLD characters, names and related indicia are © & TM Warner Bros. Entertainment Inc. WB SHIELD: © & TM WBEI. Publishing Rights © JKR. (s21)

© 2021 MARVEL



# Participez au grand jeu-concours de Noël LEGO®

Faites votre liste de Noël et tentez  
de gagner de nombreux cadeaux !



Rendez-vous sur  
[LEGOMagiqueNoel.com](http://LEGOMagiqueNoel.com)



**LEGO**

**duplo**



2304  
Grande plaque de base  
verte LEGO® DUPLO®  
A partir de 1½ ans



IDÉES

SUPPLÉMENTAIRES  
INCLUSES



10914  
La boîte  
de briques deluxe  
A partir de 1½ ans

APPRENDRE  
LES FORMES  
ET LES COULEURS



10955  
Le train  
des animaux  
A partir de 1½ ans



10913  
La boîte  
de briques  
A partir de 1½ ans



10957  
L'hélicoptère des pompiers et la voiture de police  
A partir de 1½ ans



1  
2 3  
**APPRENDRE  
À COMPTER**



10954  
Le train des chiffres -  
Apprendre à compter  
A partir de 1½ ans



**NOUVEAUTÉ  
Juin**

**AFFICHE  
INCLUSE**



Téléchargez  
LE CATALOGUE 3D

1½+  
Ans

LEGO® DUPLO®



10953  
La licorne  
A partir de  
1½ ans

A  
B C  
**APPRENDRE  
L'ALPHABET**

10915  
Le camion des lettres  
A partir de 1½ ans



**26  
LETTRES**



# duplo

10947  
Les voitures  
de course  
A partir de 2 ans



2x  
ACTIONNEMENT  
PAR POUSSÉE

ACTIONNEMENT  
PAR POUSSÉE

ACTIONNEMENT  
PAR POUSSÉE

**NOUVEAUTÉ**  
Juin

MOTRICITÉ  
FINE

IMAGINATION  
ET CRÉATIVITÉ

10944  
La mission de  
la navette spatiale  
A partir de 2 ans



**NOUVEAUTÉ**  
Mai



10945  
Le camion poubelle  
et le tri sélectif  
A partir de 2 ans



**NOUVEAUTÉ**  
Juin

MOTRICITÉ  
FINE

FORMES  
ET COULEURS





10946  
Aventures en  
camping-car en famille  
A partir de 2 ans



10961  
Avion et aéroport  
A partir de 2 ans



**NOUVEAUTÉS**  
Juin

MOTRICITÉ  
FINE

IMAGINATION  
ET CRÉATIVITÉ

1x  
BRIQUE  
LUMINEUSE



10956  
Le parc d'attractions  
A partir de 2 ans



Favorisez  
la motricité fine  
et la créativité des  
tout-petits tandis qu'ils  
explorent leur passion  
pour l'aventure et  
l'apprentissage avec les  
sets LEGO® DUPLO® !



Téléchargez  
LE CATALOGUE 3D

2+  
Ans

LEGO® DUPLO®



# duplo



10952  
La grange, le tracteur  
et les animaux  
de la ferme  
A partir de 2 ans



10949  
Les animaux  
de la ferme  
A partir de 2 ans



10950  
Le tracteur  
et les animaux  
A partir de 2 ans



10951  
L'écurie  
et les poneys  
A partir de 2 ans

MOTRICITÉ FINE  
APTITUDES SOCIALES ET ÉMOTIONNELLES

NOUVEAUTÉ Juin

1x ACTIONNEMENT PAR POUSSÉE



Téléchargez LE CATALOGUE 3D

10948  
Le garage et la station de lavage  
A partir de 2 ans



ACTIONNEMENT PAR POUSSÉE

2+ Ans

LEGO® DUPLO®

10903  
La caserne de pompiers  
A partir de 2 ans



EFFETS SONORES ET LUMINEUX

APTITUDES SOCIALES ET ÉMOTIONNELLES  
IMAGINATION ET CRÉATIVITÉ

10901  
Le camion de pompiers  
A partir de 2 ans



EFFETS SONORES ET LUMINEUX

**LEGO**

**duplo**



10932  
La boule  
de démolition  
A partir de 2 ans

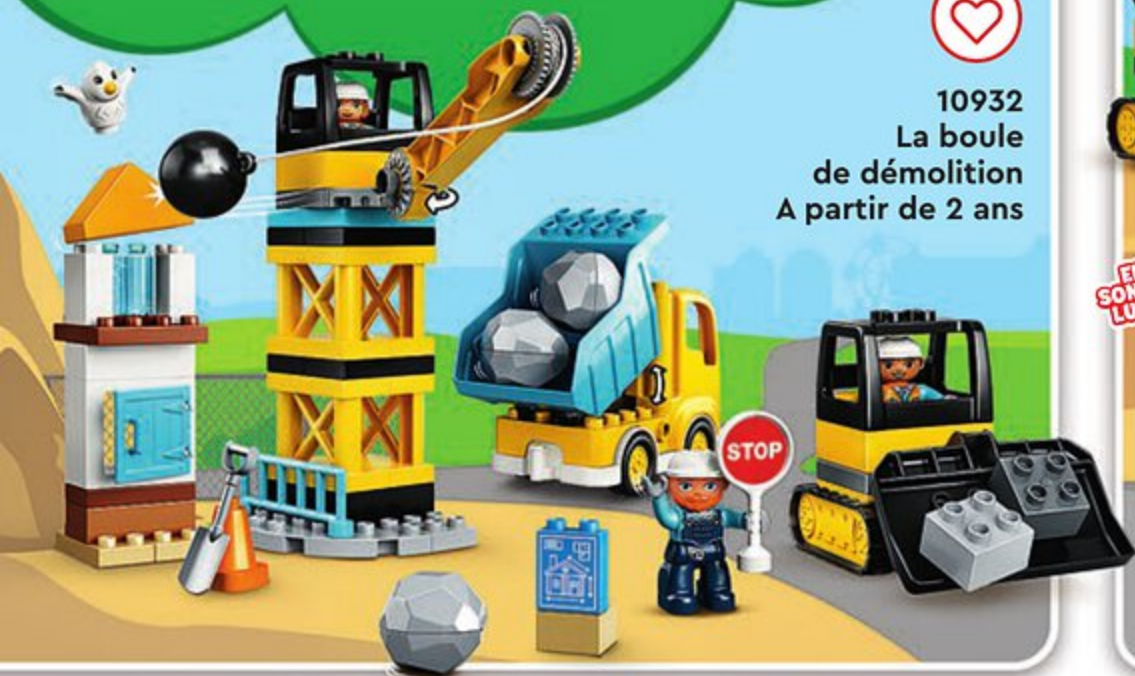

10933  
La grue et les engins  
de construction  
A partir de 2 ans



10875  
Le train de  
marchandises  
2-5 ans

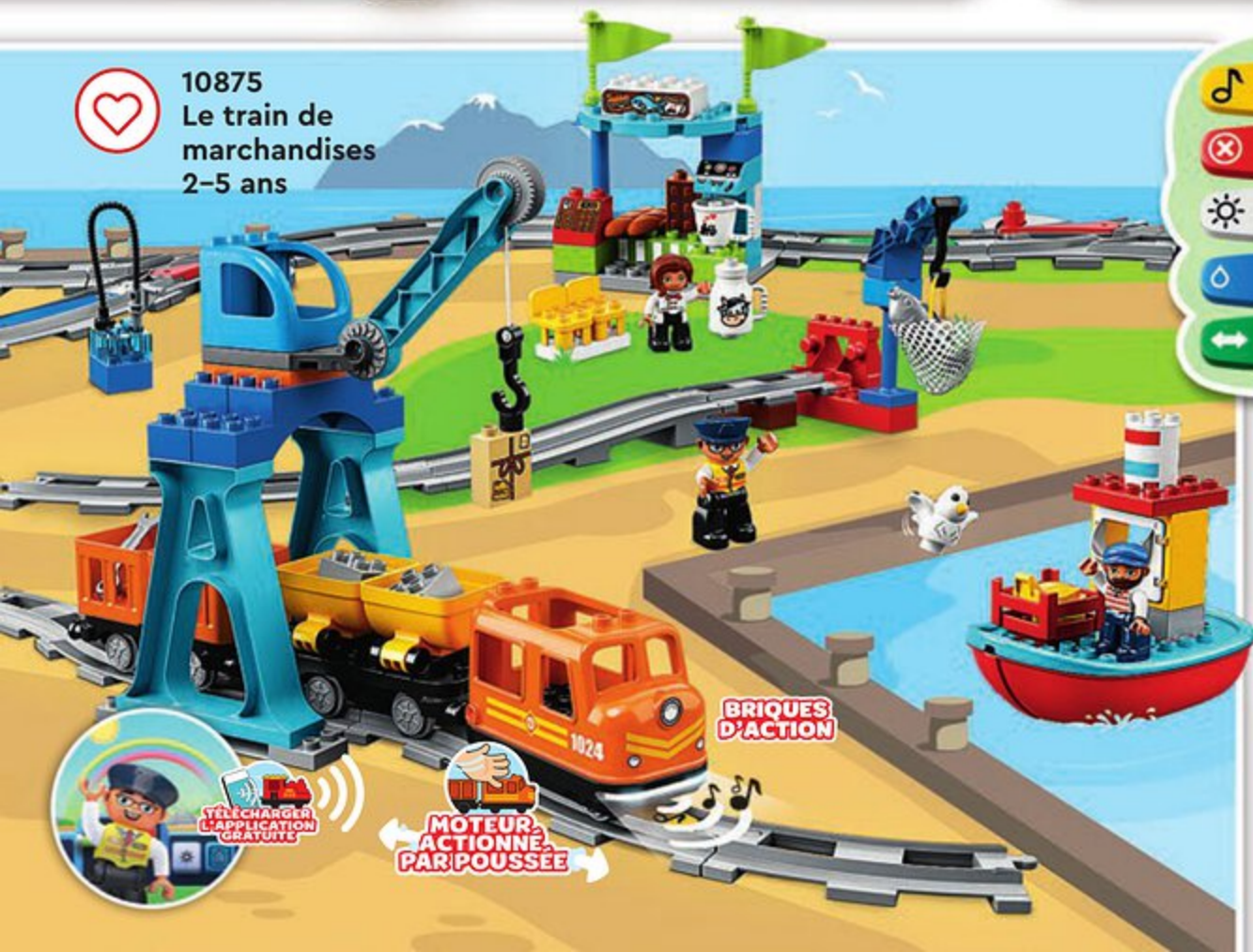

Klaxonner

S'arrêter

Allumer/  
éteindre  
la lumière

Faire  
le plein

Changer  
de direction



MOTEUR  
ACTIONNÉ  
PAR POUSSÉE

BRIQUES  
D'ACTION



10874  
Le train  
à vapeur  
2-5 ans

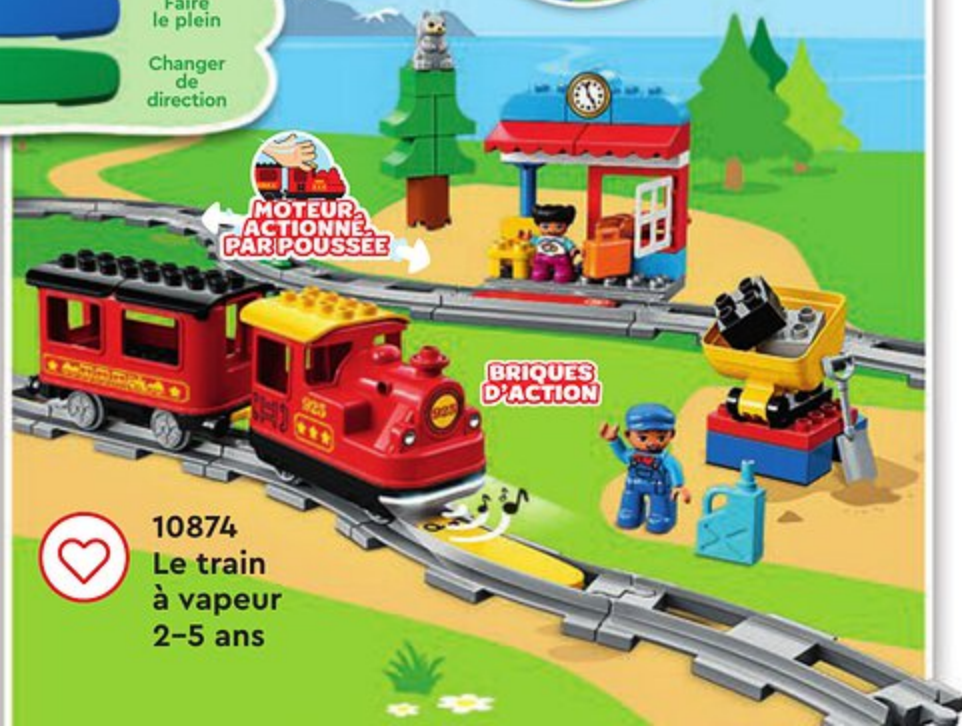

**NOUVEAUTÉ**  
Juin



10942  
La maison  
et le café  
de Minnie  
A partir de 2 ans



Disney  
JUNIOR  
**MINNIE**

©Disney



10873  
La fête  
d'anniversaire  
de Minnie  
2-5 ans



Disney  
JUNIOR  
**MINNIE**



10941  
Le train  
d'anniversaire de  
Mickey et Minnie  
A partir de 2 ans



Disney  
JUNIOR  
**MICKEY**



Téléchargez  
LE CATALOGUE 3D

2+  
Ans

LEGO® DUPLO®



# duplo

BRIQUE LUMINEUSE

10899  
Le château de la Reine des neiges  
A partir de 2 ans



Disney  
FROZEN

©Disney

10922  
Le château sous la mer d'Ariel  
A partir de 2 ans



Disney  
PRINCESS

©Disney

APTITUDES SOCIALES  
ET ÉMOTIONNELLES

IMAGINATION  
ET CRÉATIVITÉ

NOUVEAUTÉ  
Juin

10939  
L'évasion du T. rex  
et du Tricératops  
A partir de 2 ans



NOUVEAUTÉ  
Juin



© Universal City Studios LLC  
and Amblin Entertainment, Inc.  
All Rights Reserved.



10940  
Le QG de  
Spider-Man  
A partir de 2 ans

MARVEL  
SPIDEY  
AMAZING FRIENDS

© 2021 MARVEL



# CLASSIC

Les sets LEGO® Classic permettent de construire et de laisser libre cours à sa créativité. LEGO Classic est une expérience de construction au coeur du monde LEGO, qui encourage à imaginer, créer et s'exprimer.



Téléchargez  
LE CATALOGUE 3D

**NOUVEAUTÉ**  
Juin



11015  
Briques créatives  
« Autour du monde »  
A partir de 4 ans

DE NOMBREUSES  
ROUES  
DIFFÉRENTES



11014  
Briques et roues  
A partir de 4 ans



10713  
La valisette  
de construction  
4-99 ans



11012  
Briques blanches  
créatives  
A partir de 4 ans



BRIQUES  
TRANSPARENTES



10700  
La plaque  
de base verte  
4-99 ans



10696  
La boîte de briques  
créatives LEGO®  
4-99 ans



10698  
Boîte de briques  
créatives deluxe LEGO®  
4-99 ans



11013  
Briques transparentes  
créatives  
A partir de 4 ans

2+  
Ans

LEGO® DUPLO®  
LEGO® CLASSIC



# CREATOR™



**31105**  
Le magasin  
de jouets du  
centre-ville  
A partir de 8 ans



**31108**  
Les vacances en  
caravane en famille  
A partir de 9 ans



**31118**  
La maison sur la  
plage du surfer  
A partir de 8 ans



**31116**  
La cabane dans  
l'arbre du safari  
A partir de 7 ans





**31102**  
Le dragon de feu  
A partir de 7 ans



**31058**  
Le dinosaure féroce  
7 - 12 ans

**3 EN 1**



Téléchargez  
LE CATALOGUE 3D

7+  
Ans

**NOUVEAUTÉ**  
Juin



**31119**  
La grande roue  
A partir de 9 ans



**31112**  
Le lion sauvage  
A partir de 7 ans



Découvres-en plus en ligne :



[LEGO.com/creator](http://LEGO.com/creator)



# CREATOR™



31114  
La super moto  
A partir de 8 ans



31111  
Le cyber drone  
A partir de 6 ans



31113  
Le transporteur de  
voitures de course  
A partir de 7 ans



31117  
L'aventure en  
navette spatiale  
A partir de 8 ans

# 3 EN 1

NOUVEAUTÉ  
Juin



31109  
Le bateau pirate  
A partir de 9 ans





# Disney



43192  
Le carrosse royal  
de Cendrillon  
A partir de 6 ans



43189  
Les aventures d'Elsa et Nokk  
dans un livre de contes  
A partir de 5 ans



43196  
Le château de la  
Belle et la Bête  
A partir de 6 ans



**NOUVEAUTÉS  
Juin**



43194  
Le monde féérique  
d'Anna et Elsa de la  
Reine des Neiges  
A partir de 4 ans



Téléchargez  
LE CATALOGUE 3D

4+  
Ans

LEGO® CREATOR  
LEGO® | DISNEY

Disney  
PRINCESS

©Disney

Disney  
FROZEN



**LEGO**

**Disney**

Pars à l'aventure avec Raya de Disney et ses amis dans les sets LEGO® | *Disney Raya et le dernier dragon*. Rejoue tes scènes favorites du film ou invente de toutes nouvelles histoires !



43185  
Le bateau  
de Boun  
A partir de 6 ans

43184  
Raya et le dragon Sisu  
A partir de 6 ans



©Disney



43181



43184



43181  
Raya et le Palais  
du Cœur  
A partir de 7 ans



Disney  
**RAYA**  
AND  
THE LAST DRAGON



# Friends™

Découvre toutes les passionnantes aventures de plein air et les fantastiques endroits à visiter de Heartlake City !



Téléchargez  
LE CATALOGUE 3D

6+  
Ans



41683  
Le centre équestre  
de la forêt  
A partir de 7 ans

**NOUVEAUTÉS**  
Juin

41679  
La maison  
dans la forêt  
A partir de 6 ans



41681  
Le camping-car  
et le voilier  
de la forêt  
A partir de 7 ans



41679



MIA ANN AVA

41681



STÉPHANIE EMMA ETHAN

41683



MIA SAVANNAH KEVIN

LEGO.com/friends



# Friends™

Rends-toi à la fête foraine magique de Heartlake City avec tes meilleures amies !



Tour de magie



41685  
Les montagnes  
russes de la fête  
foraine magique  
A partir de 8 ans

NOUVEAUTÉS  
Juin



Tour de magie



41687  
Les stands de la fête  
foraine magique  
A partir de 6 ans



**41689**  
**La grande roue et le toboggan magiques**  
 À partir de 7 ans



Téléchargez  
 LE CATALOGUE 3D

**6+**  
 Ans

**NOUVEAUTÉS**  
**Juin**



**41688**  
**La roulotte magique**  
 À partir de 7 ans



**41686**  
**Les acrobaties magiques**  
 À partir de 6 ans



[LEGO.com/friends](http://LEGO.com/friends)

41685



ANDRÉA STELLA CAMILA CLAIRE

41686



OLIVIA STELLA

41687



EMMA CAMILA HENRY

41688



MIA CLAIRE

41689



MIA STÉPHANIE RIVER

**LEGO**

**Friends™**

41449  
La maison  
familiale d'Andréa  
A partir de 6 ans



41443  
La voiture  
électrique  
d'Olivia  
A partir de 6 ans



41448  
Le cinéma de  
Heartlake City  
A partir de 7 ans



41450  
Le centre  
commercial de  
Heartlake City  
A partir de 8 ans



41444  
Le café biologique de  
Heartlake City  
A partir de 6 ans



41443



OLIVIA MIA

41444



MIA MARCEL AVA

41448



ANDRÉA JULIAN AMELIA

41449



ANDRÉA STÉPHANIE MARTIN DONNA LIZ

41450



OLIVIA EMMA JUNE ROBERT HENRY SOPHIE





Téléchargez  
LE CATALOGUE 3D

6+  
Ans

LEGO® FRIENDS



Accessoires d'hiver inclus

Accessoires d'automne inclus



41684  
Le grand hôtel de  
Heartlake City  
A partir de 8 ans

**NOUVEAUTÉ**  
Juin



41682  
L'école de  
Heartlake City  
A partir de 6 ans

41682



OLIVIA JULIAN MARISA

41684



EMMA STÉPHANIE AMELIA RIVER

LEGO.com/friends



# Friends™

41428  
La maison  
sur la plage  
A partir de  
6 ans



41395  
Le bus de l'amitié  
A partir de 8 ans



41429  
L'avion de Heartlake City  
A partir de 7 ans



41391  
Le salon de  
coiffure de  
Heartlake City  
A partir de 6 ans



41391



NINA

EMMA

41395



MIA

STÉPHANIE

OLIVIA

41428



ANDRÉA

MIA

41429



STÉPHANIE

OLIVIA

ASHLEY



**41667**  
Le cube de jeu vidéo d'Olivia  
A partir de 6 ans



**41669**  
Le cube de football de Mia  
A partir de 6 ans



Téléchargez  
LE CATALOGUE 3D

6+  
Ans



**41670**  
Le cube de danse de Stéphanie  
A partir de 6 ans



**41671**  
Le cube de natation d'Andréa  
A partir de 6 ans



**41668**  
Le cube de mode d'Emma  
A partir de 6 ans

**NOUVEAUTÉS**  
Juin



[LEGO.com/friends](http://LEGO.com/friends)

# LEGO Friends™

Aide Mia, Emma, Stéphanie, Olivia et Andréa à prendre soin des animaux !



**41446**  
La clinique vétérinaire de Heartlake City  
A partir de 6 ans

**41441**  
Le dressage de chevaux et la remorque  
A partir de 4 ans

**4+**



**41441**



STÉPHANIE EMMA

**41445**  
L'ambulance de la clinique vétérinaire  
A partir de 6 ans



**41445**



EMMA OLIVIA

**41446**



MIA DONNA SAVANNAH



**41424**  
**La base de sauvetage**  
**dans la jungle**  
 A partir de 8 ans



Téléchargez  
 LE CATALOGUE 3D

4+  
 Ans



**41423**  
**Le sauvetage**  
**des tigres en**  
**montgolfière**  
 A partir de 7 ans



**41422**  
**La cabane des**  
**pandas dans la jungle**  
 A partir de 7 ans



**41421**  
**Le sauvetage**  
**du bébé**  
**éléphant**  
 A partir de 6 ans



41421



STÉPHANIE EMMA

41422



OLIVIA MIA

41423



ANDRÉA EMMA

41424



ANDRÉA MIA OLIVIA

LEGO.com/friends



# DOTS™

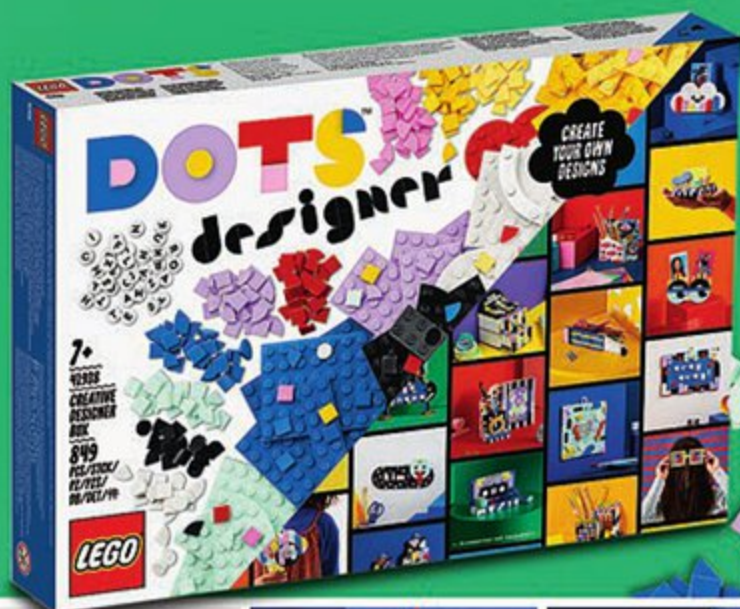

41938  
Boîte de loisirs créatifs  
A partir de 7 ans

NOUVEAUTÉ  
Juin

CRÉE TON  
PROPRE  
STYLE



41936  
Pot à crayons  
A partir de 6 ans

NOUVEAUTÉ  
Juin



#DÉCORETONUNIVERS



41924  
Support secret  
A partir de 6 ans



41925  
Les Boîtes à secrets  
A partir de 6 ans

NOUVEAUTÉ  
Juin



41937  
Multi-pack  
ambiance estivale  
A partir de 6 ans





41934  
Les bracelets  
Lumière étoilée  
A partir de 6 ans



41909  
Les bracelets  
Sirènes  
A partir de 6 ans



41910  
Les bracelets  
Crème glacée  
A partir de 6 ans



41918  
Les bracelets  
d'Aventure  
A partir de 6 ans



2

BRACELETS



41923  
Les bracelets  
Monstres  
A partir de 6 ans

41933  
Le bracelet Musical  
A partir de 6 ans



41922  
Le bracelet Cactus  
A partir de 6 ans



NOUVEAUTÉ  
Août



41939  
Porte-clés dragon  
A partir de 6 ans

NOUVEAUTÉ  
Août



41940  
Porte-clés licorne  
A partir de 6 ans



41928  
Porte-clés narval  
A partir de 6 ans



41927  
Porte-clés chien  
A partir de 6 ans



41929  
Porte-clés léopard  
A partir de 6 ans



41930  
Porte-clés panda  
A partir de 6 ans



Téléchargez  
LE CATALOGUE 3D

6+  
Ans

LEGO® DOTS

PORTE-  
CLÉS



# SUPER MARIO™

## TON AVENTURE COMMENCE ICI !

Lance-toi dans de nouvelles aventures avec les personnages LEGO® Mario™ et LEGO® Luigi™ interactifs ! Complète et personnalise ton pack de démarrage LEGO® Super Mario™ avec les nouveaux ensembles d'extension pour créer des niveaux inédits.

RECONNAISSANCE DES BRIQUES ET DES COULEURS

MUSIQUE ET SON

MUSIQUE ET SON

RECONNAISSANCE DES BRIQUES ET DES COULEURS

CONNEXION BLUETOOTH™

CONNECTE-TOI POUR JOUER À PLUSIEURS

APPUIE ICI POUR JOUER !

ÉCRAN LCD

INSTRUCTIONS DE MONTAGE NUMÉRIQUES ET IDÉES INSPIRANTES DANS L'APPLI GRATUITE

Vérifie la compatibilité sur [LEGO.com/devicecheck](https://LEGO.com/devicecheck)

[LEGO.com/supermario](https://LEGO.com/supermario)

FAIS ÉQUIPE POUR DE NOUVELLES AVENTURES

**NOUVEAUTÉ**  
Août



TES NIVEAUX, TES AVENTURES !

71387  
Pack de Démarrage  
Les Aventures de Luigi  
A partir de 6 ans

DÉCOUVRE LES NOUVEAUX SETS !

71360  
Pack de Démarrage  
Les Aventures de Mario  
A partir de 6 ans

Appareil connecté nécessaire mais non inclus

Piles non incluses



TM & © 2021 Nintendo. The Bluetooth® word mark and logos are registered trademarks owned by Bluetooth SIG, Inc. and any use of such marks by the LEGO Group is under license. Other trademarks and trade names are those of their respective owners.

# PACK DE DÉMARRAGE



71360



71387



## PACK DE DÉMARRAGE 71360 OU 71387 NÉCESSAIRE



71388



71389



71390



71391



71394

10 FIGURINES À  
COLLECTIONNER  
**SÉRIE 3**

71394  
Pack surprise  
de personnage  
- Série 3  
A partir de 6 ans



Téléchargez  
LE CATALOGUE 3D

6+  
Ans

71388  
Ensemble d'extension  
La tour infernale  
du Boss Frère Sumo  
A partir de 6 ans

LEGO® Mario™  
non inclus



71390  
Ensemble d'extension  
La destruction  
des Reznors  
A partir de 8 ans

COMPLÈTE  
TON PACK  
DE  
DÉMARRAGE



LEGO® Mario™  
non inclus

71391  
Ensemble d'extension La forteresse  
volante de Bowser  
A partir de 8 ans

LEGO® Mario™  
non inclus



71389  
Ensemble d'extension  
Le monde du Ciel de Lakitu  
A partir de 7 ans

LEGO® Mario™  
non inclus



ENSEMBLES D'EXTENSION

33

LEGO® SUPER MARIO™



# PACK DE DÉMARRAGE 71360 OU 71387 NÉCESSAIRE



**FAIS  
REBONDIR  
MARIO**

LEGO® Mario™ non inclus



**71392**  
Pack de Puissance  
Mario grenouille  
A partir de  
6 ans



**NOUVEAUTÉ  
Août**



**71393**  
Pack de Puissance  
Mario abeille  
A partir de  
6 ans



TM & © 2021 Nintendo.

[LEGO.com/supermario](http://LEGO.com/supermario)

**FAIS  
VOLER  
MARIO**

**71362**  
Ensemble d'extension  
La forteresse de  
la Plante Piranha  
A partir de 8 ans



**COMPLÈTE  
TON PACK  
DE  
DÉMARRAGE**

**71380**  
Set de créateur Invente  
ton aventure  
A partir de 6 ans



**CONSTRUIS ET  
PERSONNALISE  
TES PROPRES  
NIVEAUX**

**71383**  
Ensemble d'extension  
Le marais empoisonné  
de Wiggler  
A partir de 7 ans



**71369**  
Ensemble d'extension  
La bataille du château de Bowser  
A partir de 8 ans



**COSTUMES**

The Bluetooth® word mark and logos are registered trademarks owned by Bluetooth SIG, Inc. and any use of such marks by the LEGO Group is under license. Other trademarks and trade names are those of their respective owners.

**ENSEMBLES D'EXTENSION**

# VIDIYO™

CRÉATEUR  
DE CLIPS  
MUSICAUX

L'UNIVERS LEGO® VIDIYO™ PROPOSE UNE FORMIDABLE NOUVELLE EXPÉRIENCE DE JEU SOCIAL, QUI PERMET AUX ENFANTS DE DEVENIR DES RÉALISATEURS, DES PRODUCTEURS ET DES STARS EN CRÉANT LEURS PROPRES CLIPS MUSICAUX À PARTAGER.



Téléchargez  
LE CATALOGUE 3D

6+  
Ans

LEGO® SUPER MARIO™  
LEGO® VIDIYO™

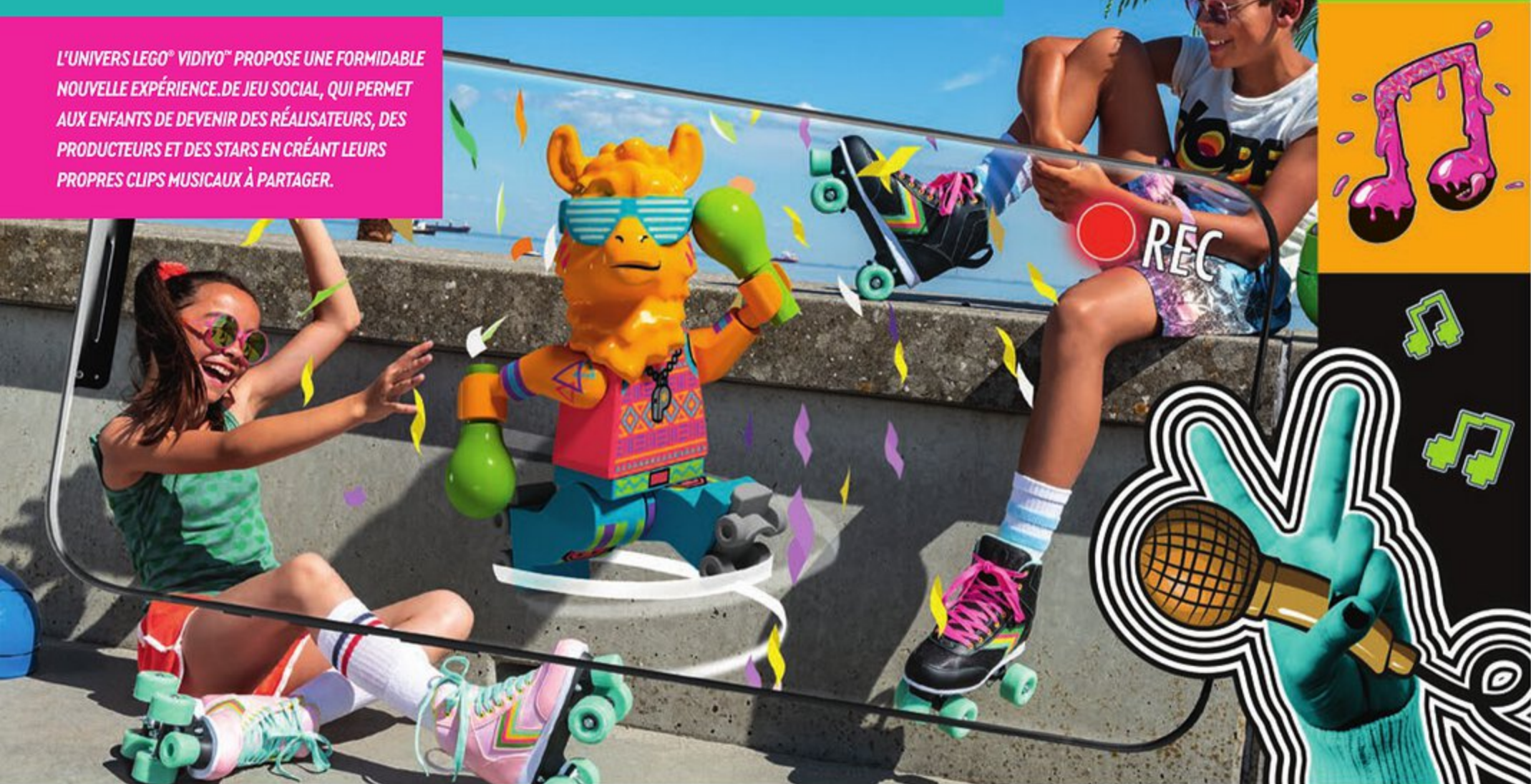

## 1. TÉLÉCHARGE

GRATUITEMENT L'APPLICATION LEGO® VIDIYO™



## 2. CHOISIS

TA MUSIQUE DANS LA BIBLIOTHÈQUE



## 3. SCANNE

TON BANDMATE ET TES BEATBITS



## 4. ENREGISTRE

TES PROPRES CLIPS MUSICAUX



LEGO

# VIDIYO™

CRÉATEUR  
DE CLIPS  
MUSICAUX

LES BEATBITS SONT DES TUILES QUI DÉCLENCHENT DE FANTASTIQUES EFFETS SPÉCIAUX DANS L'APPLICATION VIDIYO, PERMETTANT AINSI AUX ENFANTS DE CRÉER DES CLIPS MUSICAUX UNIQUES. AVEC PLUS DE 90 BEATBITS, LES ENFANTS PEUVENT SANS CESSER PRODUIRE DE NOUVELLES CRÉATIONS.



43105  
Party Llama BeatBox  
A partir de 7 ans



16

BEATBITS  
D'EFFETS  
SPÉCIAUX  
INCLUS

LES BEATBITS PEUVENT VARIER



43107  
HipHop  
Robot  
BeatBox  
A partir de  
7 ans



ROBO  
HIPHOP



43104  
Alien DJ  
BeatBox  
A partir de  
7 ans



ETDM



43103  
Punk Pirate  
BeatBox  
A partir de  
7 ans



43102  
Candy  
Mermaid  
BeatBox  
A partir de  
7 ans



43106  
Unicorn  
DJ  
BeatBox  
A partir de  
7 ans



NOUVEAUTÉ  
Juin

43109  
Metal  
Dragon  
BeatBox  
A partir de  
7 ans



MUNSTER  
METAL

NOUVEAUTÉ  
Juin

43110  
Folk Fairy  
BeatBox  
A partir de  
7 ans



Fantasy  
FOLK

BANDMATES  
SERIE 2

NOUVEAUTÉ  
Octobre

43108  
Bandmates  
A partir de  
7 ans



43114  
Punk Pirate Ship  
A partir de 8 ans



PERSONNALISE

TON EXPÉRIENCE NUMÉRIQUE  
AVEC UN ARRIÈRE-PLAN ET DES  
HAUT-PARLEURS



Téléchargez  
LE CATALOGUE 3D

7+  
Ans



43112  
Robo  
HipHop Car  
A partir de  
7 ans



43115  
The Boombox  
A partir de 9 ans



NOUVEAUTÉS  
Juin

43111  
Candy Castle  
Stage  
A partir de  
7 ans



43113  
K-Pawp Concert  
A partir de 8 ans



LEGO® VIDIYO™



**LEGO****CITY**

**ACTIVE LA RÉTROFRICITION  
STUNTZ POUR DES CASCADES  
QUI DONNENT LE TOURNIS !**



**60295**  
L'arène de  
spectacle des  
cascadeurs  
A partir de 6 ans



**NOUVEAUTÉS  
Octobre**



**60293**  
L'aire  
d'entraînement  
des cascadeurs  
A partir de 5 ans



**60299**  
Le spectacle des  
cascadeurs  
A partir de 5 ans



Téléchargez  
LE CATALOGUE 3D

5+  
Ans

LEGO® CITY

**NOUVEAUTÉS  
Octobre**



60294  
Le camion de  
spectacle des  
cascadeurs  
A partir de 6 ans



**DÉCOUVRE  
STUNTZ**



**CASCADEUR  
PROFESSIONNEL.**

**N'ESSEY PAS  
DE REPRODUIRE CES  
CASCADES SUR UNE  
VRAIE MOTO.**



60309  
La moto de  
cascade Selfie  
A partir de 5 ans



60311  
La moto de  
cascade de Feu  
A partir de 5 ans



60298  
La moto de  
cascade Fusée  
A partir de 5 ans



60310  
La moto de  
cascade du Poulet  
A partir de 5 ans



60296  
La moto de  
cascade Roue  
arrière  
A partir de 5 ans



60297  
La moto de cascade  
Démolition  
A partir de 5 ans



**STUNTZ**

**LEGO** CITY

60215  
La caserne  
de pompiers  
A partir  
de 5 ans

EFFETS SONORES  
ET LUMINEUX



**PROTÈGE LA VILLE AVEC LES  
POMPIERS DE LEGO® CITY!**

ÉTEINS  
LES FEUX



60282  
L'unité de commandement  
des pompiers  
A partir de 6 ans

ÉTEINS  
LES FEUX



60216  
Les pompiers du  
centre-ville  
A partir de 6 ans

60281  
L'hélicoptère de  
secours des pompiers  
A partir de 5 ans

CLEMMONS



POMPE À EAU

ÉTEINS  
LES FEUX



# VIENS EN AIDE AUX ANIMAUX ET EXPLORER LA SAVANE!

JESSICA SHARPE



 **60300**  
Le quad de sauvetage des animaux sauvages  
A partir de 5 ans



 **60301**  
Le tout-terrain de sauvetage des animaux sauvages  
A partir de 4 ans



Téléchargez  
LE CATALOGUE 3D

5+  
Ans

LEGO® CITY

## NOUVEAUTÉS Juin



 **60302**  
L'opération de sauvetage des animaux sauvages  
A partir de 6 ans





# CITY

## BIENVENUE À LEGO® CITY, UNE VILLE À CONSTRUIRE AU GRÉ DE TES ENVIES !

**PLAQUES  
DE ROUTE  
INCLUSES**

60292  
Le centre-ville  
A partir de 6 ans



### RELIE TA VILLE

60290  
Le skatepark  
A partir de 5 ans



**PLAQUES  
DE ROUTE  
INCLUSES**

**PLAQUES  
DE ROUTE  
INCLUSES**

60291  
La maison  
familiale  
A partir de 5 ans



# ASSURE LA SÉCURITÉ DE LEGO® CITY



**60244**  
Le transport de l'hélicoptère de la police  
A partir de 5 ans



**ROOKY**  
PARTNIR

**FRANKIE**  
LUPELLI



**HÉLICOPTÈRE VOLANT**



**AIMANT**

**TOM**  
BENNETT

**GRANDE**  
BETTY



**60245**  
Le cambriolage de la banque  
A partir de 5 ans



Téléchargez  
LE CATALOGUE 3D

5+  
Ans

LEGO® CITY



**AIMANT**

**SAM**  
GRIZZLED

**SNAKE**  
RATTLER

**60243**  
L'arrestation en hélicoptère  
A partir de 5 ans



**WHEELER**

**DAISY**  
KABOOM

**DUKE**  
DETAIN



**60246**  
Le commissariat de police  
A partir de 6 ans



**EFFETS SONORES ET LUMINEUX**



**BRIQUE LUMINEUSE**





# CITY



**60289**  
Le transport d'avion  
de voltige  
A partir de 5 ans



**60285**  
La voiture de sport  
A partir de 5 ans



**60283**  
Le camping-car  
de vacances  
A partir de 5 ans



**60288**  
Le transport du  
buggy de course  
A partir de 5 ans



**ROUES  
DIRECTRICES**



# DÉCOUVRE L'OCÉAN AVEC LES EXPLORATEURS DE LEGO® CITY!



60266  
Le bateau d'exploration  
océanique  
A partir de 7 ans



4+

60263  
Le mini  
sous-marin  
A partir de 4 ans



LE BATEAU FLOTTE

Le sous-marin ne flotte pas



BRILLE  
DANS LE NOIR

60264  
Le sous-marin  
d'exploration  
A partir de 5 ans



60265  
La base  
d'exploration  
océanique  
A partir de 6 ans



Téléchargez  
LE CATALOGUE 3D

4+  
Ans

LEGO® CITY



60197  
Le train de passagers  
télécommandé  
6-12 ans



PRENDS LES  
COMMANDES



60198  
Le train de marchandises  
télécommandé  
6-12 ans

4+

60261  
L'aéroport  
central  
A partir de 4 ans



60262  
L'avion de  
passagers  
A partir de 6 ans





# LEGO minifigures™

**NOUVEAUTÉS**  
Septembre



Téléchargez  
LE CATALOGUE 3D

4+  
Ans



ÉDITION LIMITÉE  
**12**  
À COLLECTIONNER



71031  
Marvel Studios  
A partir de  
5 ans

LEGO® CITY  
LEGO® MINIFIGURES

MARVEL STUDIOS

WandaVision

MARVEL STUDIOS

THE FALCON  
AND THE  
WINTER SOLDIER

MARVEL STUDIOS

LOKI

MARVEL STUDIOS

WHAT IF...?



**LEGO**

MARVEL STUDIOS

# THE INFINITY SAGA



76193  
Le vaisseau des  
Gardiens  
A partir de 14 ans



**NOUVEAUTÉS**  
Juin



76190  
Iron Man : la  
destruction d'Iron  
Monger  
A partir de 9 ans





# NOUVEAUTÉS Juin



Téléchargez  
LE CATALOGUE 3D

4+  
Ans

LEGO® MARVEL AVENGERS

76186  
Le dragon volant  
de Black Panther  
A partir de 8 ans



76192  
Le combat final  
d'Avengers: Endgame  
A partir de 8 ans



76189  
L'affrontement entre  
Captain America  
et Hydra  
A partir de 4 ans



76186



BLACK PANTHER SHURI CHITAUURI

76189



CAPTAIN AMERICA AGENT D'HYDRA

76192



ANT-MAN CAPTAIN AMERICA IRON MAN THOR SORCIÈRE ROUGE BLACK PANTHER CHITAUURI THANOS

© 2021 MARVEL





# MARVEL AVENGERS

4+



76170  
Iron Man  
contre Thanos  
A partir de 4 ans



76166  
La tour de combat  
des Avengers  
A partir de 8 ans



4+



76153  
L'hélicoptère  
des Avengers  
A partir de 9 ans



76152  
La colère  
de Loki  
A partir de 4 ans

76152



CAPTAIN IRON  
MARVEL MAN THOR  
LOKI HULK

76153



IRON MAN THOR  
BLACK WIDOW CAPTAIN  
MARVEL WAR MACHINE  
NICK FURY AGENT DE  
L'A.I.M. M.O.D.O.K.

76166



IRON MAN BLACK  
WIDOW BLAZER TAZER  
CRANE ROUGE AGENT DE  
L'A.I.M. AGENT DE  
L'A.I.M.

76170



IRON MAN  
THANOS



© 2021 MARVEL



MARVEL STUDIOS  
**SHANG-CHI**  
AND THE LEGEND OF THE TEN RINGS

MARVEL STUDIOS  
**SPIDER-MAN**  
*No Way Home*

ENCORE PLUS DE  
**SETS LEGO® MARVEL**  
À DÉCOUVRIR PROCHAINEMENT

MARVEL STUDIOS  
**WHAT IF...?**

MARVEL  
**ETERNALS**



MARVEL  
**AVENGERS**



76169  
L'armure robot de Thor  
A partir de 7 ans



76168  
L'armure robot de Captain America  
A partir de 7 ans



CAPTAIN AMERICA



THOR



MILES MORALES



76171  
L'armure robot de Miles Morales  
A partir de 7 ans



MARVEL  
**SPIDER-MAN**



Téléchargez  
LE CATALOGUE 3D

7+  
Ans

LEGO® MARVEL AVENGERS  
LEGO® MARVEL SPIDER-MAN



76175  
L'attaque  
contre le repaire  
de Spider  
A partir de 8 ans



76173  
Spider-Man et Ghost Rider  
contre Carnage  
A partir de 7 ans



76174  
Le camion monstre de  
Spider-Man contre  
Mystério  
A partir de 8 ans

76173



SPIDER-MAN GHOST RIDER CARNAGE

76174



SPIDER-MAN SPIDER-GWEN MYSTÉRIO DOCTEUR OCTOPUS

76175



SPIDER-MAN PETER PARKER L'ARMURE D'IRON SPIDER SPIDER-MAN SUPRÊME BOUFFON VERT VENOM



© 2021 MARVEL



76239  
La Batmobile™ Tumbler :  
la confrontation avec  
l'Épouvantail  
A partir de 8 ans



76180  
Batman™ contre  
le Joker™ : course-poursuite  
en Batmobile  
A partir de 4 ans



**NOUVEAUTÉ**  
Octobre



4+

76159  
La poursuite du  
Joker en moto  
à 3 roues  
A partir de 7 ans



4+

76158  
La poursuite  
du Pingouin  
en Batbateau  
A partir de 4 ans



76158



LE PINGOUIN BATMAN™

76159



BATMAN™ ROBIN™ HARLEY QUINN™ LE JOKER™

76180



BATMAN™ BATGIRL™ LE JOKER™

76239



L'ÉPOUVANTAIL BATMAN™



BATMAN and all related characters and elements  
© & ™ DC Comics. WB SHIELD: © & ™ WBEL. (s21)

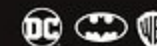

**LEGO**

# MINDSTORMS®



Téléchargez  
LE CATALOGUE 3D

**CODER ET  
CONTRÔLER**

AVEC LE CODAGE  
VISUEL ET TEXTUEL



51515  
Robot Inventor  
A partir de 10 ans

CONSTRUIRE ET CODER  
**JOUER**  
RECONSTRUIRE



TRICKY



M.V.P.



CHARLIE

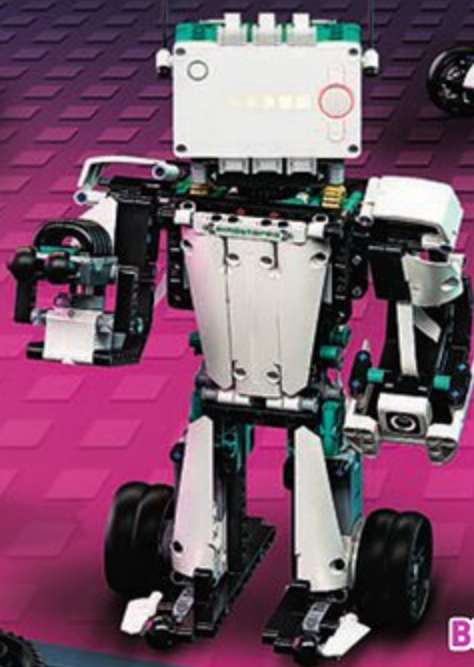

BLAST



GELO

5 EN 1

APPLIQUANT PLUS DE  
**50**  
ACTIVITÉS



LEGO® MINDSTORMS®  
ROBOT INVENTOR  
Vérifier la compatibilité :  
[LEGO.com/devicecheck](http://LEGO.com/devicecheck)  
Instructions de montage  
numériques uniquement

4+  
Ans

LEGO® DC BATMAN™  
LEGO® MINDSTORMS®  
LEGO® BOOST

**LEGO**

# BOOST

BUILD CODE PLAY

BONJOUR!

DONNE VIE À TES  
CRÉATIONS LEGO®



VERNIE  
LE ROBOT



17101  
Mes premières  
constructions  
LEGO® Boost  
7-12 ans

PLUS DE **70**  
ACTIVITÉS



LEGO® BOOST  
Vérifier la compatibilité  
[LEGO.com/devicecheck](http://LEGO.com/devicecheck)

MODÈLE  
**5 EN 1**

GUITARE  
4000

L'AUTO-  
CONSTRUCTEUR

M.T.R.4

FRANKIE  
LECHAT



# NINJAGO

REVIS LES FORMIDABLES AVENTURES DE LA SÉRIE TÉLÉVISÉE  
LEGO® NINJAGO®: L'APPEL DE L'OcéAN! REJOINS LES NINJAS DANS LEUR  
COMBAT CONTRE LES FORCES DU MAL POUR OBTENIR DE PRÉCIEUSES  
AMULETTES ET SAUVER NINJAGO CITY, AINSI QUE LE MONDE ENTIER, DE LA  
DESTRUCTION!

**NOUVEAUTÉS**  
Juin

71750  
Le robot Hydro de Lloyd  
A partir de 7 ans



71750



COLE  
PLONGEUR GARDE  
MARRAY

71752



JAY  
COLE  
GARDE  
GARDE  
PLONGEUR PLONGEUR  
MARRAY MARRAY

71754



NYA  
ZANE  
GARDE  
GARDE  
PLONGEUR  
MARRAY MARRAY  
LE PRINCE  
KALMARR

71752  
Le bolide ninja sous-marin  
A partir de 8 ans

71754  
Le dragon d'eau  
A partir de 9 ans



LEGO.com/NINJAGO





Téléchargez  
LE CATALOGUE 3D

7+  
Ans

LEGO® NINJAGO®



71756  
L'Hydro Bounty  
A partir de 9 ans

NOUVEAUTÉS  
Juin



71755  
Le temple de la  
Mer sans fin  
A partir de 9 ans

71756

71755



NRG

KAI

LE PRINCE  
BENTHOMARR

GLUTINOUS

GARDE  
MARRAY

GARDE  
MARRAY

LE PRINCE  
KALMARR

ZANE

NYA

LLOYD

KAI

JAY

COLE

WU BÔT

WU BÔT

GARDE  
MARRAY

LE PRINCE  
KALMARR



# NINJAGO

71745  
La moto de la jungle de Lloyd  
A partir de 7 ans



71747  
Le village des Gardiens  
A partir de 8 ans



71746  
Le dragon de la jungle  
A partir de 8 ans



71748  
La bataille de catamarans  
A partir de 9 ans



[LEGO.com/NINJAGO](http://LEGO.com/NINJAGO)

71745



71746



71747



71748





# NINJAGO

LEGACY

**NOUVEAUTÉS**  
Juin



Téléchargez  
LE CATALOGUE 3D

71753  
L'attaque du dragon de feu  
A partir de 8 ans



71739  
Le tout-terrain ultrasonique  
A partir de 9 ans

4+  
Ans



4+

71749  
L'ultime QG  
des ninjas  
A partir de 4 ans



4+

71734  
La moto de Kai  
A partir de 4 ans



71734



71739



71749



71753



**LEGO**

# NINJAGO

LEGACY

**4+**

71740  
L'électrorobot de Jay  
A partir de 4 ans



71735  
Le tournoi des éléments  
A partir de 6 ans



71730  
Set de bataille  
épique - Kai contre  
Skulkin  
A partir de 6 ans



71731  
Set de bataille  
épique - Zane  
contre Nindroïde  
A partir de 6 ans



71732  
Set de bataille  
épique - Jay contre  
Serpentine  
A partir de 6 ans



71733  
Set de bataille  
épique - Cole  
contre le guerrier  
fantôme  
A partir de 6 ans



71735



71740

[LEGO.com/NINJAGO](http://LEGO.com/NINJAGO)

AFFRONTE DES ENNEMIS LÉGENDAIRES POUR REMPORTEZ  
DES ARMES CONVOITÉES. PUIS CÉLÈBRE 10 ANS D'AVENTURES  
PASSIONNANTES AVEC LEGO NINJAGO GRÂCE  
AUX NINJAS D'OR ÉDITION LIMITÉE DES SETS LEGACY!

71738  
Le robot  
de combat Titan  
de Zane  
A partir de 9 ans



71736  
Le jet multi-missiles  
A partir de 8 ans



Téléchargez  
LE CATALOGUE 3D

4+  
Ans

LEGO® NINJAGO®



71737  
Le chargeur  
Ninja X-1  
A partir de 8 ans

71736



LLOYD

COLE

EYEZOR

ÉDITION LIMITÉE  
KAI DORÉ  
KAI LEGACY

71737



MINDROÏDE  
GUERRIER  
MINDROÏDE

JAY

ÉDITION LIMITÉE  
COLE DORÉ  
COLE LEGACY

71738



L'ARCHER  
DE L'ÂME

GHULTAR

ZANE

ÉDITION LIMITÉE  
JAY DORÉ  
JAY LEGACY

LEGO



Aide Claire, Owen et les membres de leur équipe, à combattre les dinosaures rebelles dans la nature sauvage d'Isla Nublar. Surveillance bien tes arrières !



76942  
L'évasion en bateau  
du Baryonyx  
A partir de 8 ans



76940  
L'exposition du fossile  
du T. Rex  
A partir de 7 ans

NOUVEAUTÉS  
Septembre



4+

76939  
L'évasion  
du Stygimoloch  
A partir de 4 ans



76941  
La chasse  
du Carnotaurus  
A partir de 7 ans



© Universal City Studios LLC and Amblin Entertainment, Inc. All Rights Reserved.



# SPEED CHAMPIONS

76895  
Ferrari F8 Tributo  
A partir de 7 ans



Produced under license of Ferrari S.p.A. The name FERRARI, the PRANCING HORSE device, all associated logos and distinctive designs are property of Ferrari S.p.A. The body designs of the Ferrari cars are protected as Ferrari S.p.A. property under design, trademark and trade dress regulations.

76904  
Mopar Dodge//SRT Top Fuel Dragster et  
1970 Dodge Challenger T/A  
A partir de 8 ans



Dodge, HEMI, MOPAR and related logos, vehicle model names and trade dress are trademarks of FCA US LLC and used under license by The LEGO Group. ©2021 FCA US LLC.



Téléchargez  
LE CATALOGUE 3D

4+  
Ans

76897  
1985 Audi Sport quattro S1  
A partir de 7 ans



Trademarks, design patents and copyrights are used with the approval of the owner AUDI AG.

76902  
McLaren Elva  
A partir de 7 ans



Manufactured under license from McLaren Automotive Limited. The McLaren name and logo are registered trademarks of McLaren.

NOUVEAUTÉ  
Juin



76901  
Toyota GR Supra  
A partir de 7 ans



TOYOTA trademarks used with permission.

76900  
Koenigsegg Jesko  
A partir de 7 ans



Koenigsegg

NOUVEAUTÉ  
Juin

KOENIGSEGG, the Koenigsegg emblem, and Koenigsegg Jesko are registered trademarks and the design of the Koenigsegg Jesko car model is protected by copyright laws. The trademarks and the designs are used under a license from Koenigsegg Automotive AB.

76903  
Chevrolet Corvette  
C8.R Race Car et 1968  
Chevrolet Corvette  
A partir de 8 ans



General Motors trademarks used under license by LEGO.



LEGO® JURASSIC WORLD  
LEGO® SPEED CHAMPIONS



# Harry Potter



76382  
Poudlard : le cours de  
métamorphose  
A partir de 8 ans



76383  
Poudlard : le cours de  
potions  
A partir de 8 ans



76384  
Poudlard : le cours de  
botanique  
A partir de 8 ans



76385  
Poudlard : le cours de  
sortilèges  
A partir de 8 ans



COLLECTIONNE LES 4 !



PROFESSEUR  
MCGONAGALL  
RON  
WEASLEY™  
HERMIONE  
GRANGER™



PROFESSEUR  
ROGUE  
SEAMUS  
FINNIGAN  
DRAGO  
MALEFOY



PROFESSEUR  
CHOURAVE  
CEDRIC  
DIGGORY  
NEVILLE  
LONDBUBAT



PROFESSEUR  
FLITWICK  
CHO  
CHANG  
HARRY  
POTTER™



**NOUVEAUTÉS**  
Juin



**76386**  
Poudlard : l'erreur de  
la potion Polynectar  
A partir de 7 ans



**76387**  
Poudlard : rencontre  
avec Touffu  
A partir de 8 ans



**76388**  
Visite du village de  
Pré-au-Lard  
A partir de 8 ans



Téléchargez  
LE CATALOGUE 3D

7+  
Ans

LEGO® HARRY POTTER™

76386

76387

76388



HARRY POTTER™ ANNIVERSAIRE HARRY POTTER™ HERMIONE GRANGER™ RON WEASLEY™  
HERMIONE GRANGER™ ANNIVERSAIRE HARRY POTTER™ HERMIONE GRANGER™ RON WEASLEY™  
RON WEASLEY™ ANNIVERSAIRE HME FLUME M. FLUME MADAME ROSMERTA PROFESSEUR MCGONAGALL DEAN THOMAS HARRY POTTER™



WIZARDING WORLD characters, names and related indicia are © & ™ Warner Bros. Entertainment Inc. WB SHIELD: © & ™ WBEI. Publishing Rights © JKR. (s21)



# Harry Potter

**NOUVEAUTÉ**  
Juin



76389  
La Chambre des  
Secrets de Poudlard  
A partir de 9 ans



76389

-  LORD VOLDEMORT™
-  NICK  
ANNIVERSAIRE QUASI-SANS-TÊTE
-  TOM  
JEDUSOR
-  GILDEROY  
LOCKHART™
-  ALBUS  
DUMBLEDORE™
-  AURORA  
SINISTRA
-  HARRY  
POTTER™
-  GINNY  
WEASLEY™
-  COLIN  
CREEVEY
-  LUNA  
LOVEGOOD™
-  JUSTIN  
FINCH-FLETCHLEY

WIZARDING WORLD characters, names and related indicia are © & ™ Warner Bros. Entertainment Inc. WB SHIELD: © & ™ WBEI. Publishing Rights © JKR. (s21)



Téléchargez  
LE CATALOGUE 3D

8+  
Ans

LEGO® HARRY POTTER™

WIZARDING  
WORLD



75948  
La tour de  
l'horloge de  
Poudlard  
A partir de 9 ans



75968  
4 Privet Drive  
A partir de 8 ans



Anglia is a trademark owned and licensed by Ford Motor Company.

75957  
Le Magicobus  
A partir de 8 ans



75969  
La Tour d'astronomie  
de Poudlard  
A partir de 9 ans



75948

75957

75968

75969



MADAME MAXIME ALBUS DUMBLEDORE™ VIKTOR KRUM CEDRIC DIGGORY FLEUR DELACOUR RON WEASLEY™ HARRY POTTER™ HERMIONE GRANGER™ STAN ROCADÉ ERNIE DANIMUR HARRY POTTER™ VERNON DURSLEY PETUNIA DURSLEY DUDLEY DURSLEY RON WEASLEY™ HARRY POTTER™ DOBBY™ LAVANDE BROWN LUNA LOVEGOOD™ NEVILLE LONDBUBAT DRAGO MALEFOY HORACE SLUGHORN RON WEASLEY™ HERMIONE GRANGER™ HARRY POTTER™



# MINECRAFT



21168  
La forêt biscornue  
A partir de 8 ans



21158  
La garderie des  
pandas  
A partir de 7 ans



21169  
La première aventure  
A partir de 8 ans



21161  
La boîte de  
construction 3.0  
A partir de 8 ans



21170  
La Maison  
Cochon  
A partir de  
8 ans



21165  
La ruche  
A partir de 8 ans



© 2021 Mojang AB. All Rights Reserved. Minecraft, the MINECRAFT logo and the MOJANG STUDIOS logo are trademarks of the Microsoft group of companies.

21158



21161



21165



21168



21169



21170





Téléchargez  
LE CATALOGUE 3D

7+  
Ans

LEGO® MINECRAFT®

# NOUVEAUTÉS Juin



21174  
La cabane moderne  
dans l'arbre  
A partir de 9 ans



21176  
L'abomination de  
la jungle  
A partir de 8 ans



21171  
L'écurie  
A partir de 8 ans



21173  
La tour du ciel  
A partir de 8 ans



21172  
Le portail en ruine  
A partir de 8 ans



[LEGO.com/minecraft](http://LEGO.com/minecraft)

21173



PHANTOM X2 CHAT PILOTE

21171



CAVALIER SQUELETTE CHEVAL OUVRIER AGRICOLE BÉBÉ CHEVAL

21172



BÉBÉ MOUTON STEVE BÉBÉ HOGLIN WITHER SQUELETTE

21174



CHAT POULE X2 ZOMBIE CREEPER™ CHARGÉ SKIN PANDA SKIN OCELOT

21176



EXPLORATEUR SQUELETTE CREEPER™ ENCHANTÉ ARCHÉOLOGUE GOLEM DE FER



# STAR WARS

## STAR WARS THE MANDALORIAN

LEGO **BRICK  
HEADZ**

75317  
Le Mandalorien et  
L'Enfant  
A partir de 10 ans



75311  
Le maraudeur  
blindé impérial  
A partir de 8 ans



**NOUVEAUTÉ**  
Août

75299  
Conflit à Tatooine™  
A partir de 7 ans



75318  
L'Enfant  
A partir de 10 ans



75299



L'ENFANT



LE MANDALORIEN  
PILLARD  
TUSKEN

75311



GREEF  
KARGA



STORMTROOPER™  
D'ARTILLERIE



STORMTROOPER™



STORMTROOPER™

75318



L'ENFANT



Téléchargez  
LE CATALOGUE 3D

7+  
Ans

LEGO® STAR WARS™



75315  
Le croiseur léger impérial  
A partir de 10 ans



NOUVEAUTÉS  
Août

75312  
Le vaisseau de Boba Fett  
A partir de 9 ans



75312



BOBA FETT™



LE MANDALORIEN

75315



GROGU™



LE MANDALORIEN



CARA DUNE™



FENNEC SHAND™



MOFF GIDEON™



DARK TROOPER™



# STAR WARS

**NOUVEAUTÉ**  
Août

**MICRO-VAISSEAUX**

**75298**  
Microfighters AT-AT™  
contre Tauntaun™  
A partir de 6 ans

**75314**  
La navette d'attaque  
du Bad Batch™  
A partir de 9 ans



**75310**  
Duel sur  
Mandalore™  
A partir de 7 ans

**NOUVEAUTÉ**  
Août







Téléchargez  
LE CATALOGUE 3D

6+  
Ans

LEGO® STAR WARS™



75301  
Le X-Wing Fighter™ de Luke  
Skywalker  
A partir de 9 ans

75307  
Le calendrier  
de l'Avent  
LEGO® Star Wars™  
A partir de 6 ans



24 cadeaux  
NOUVEAUTÉ  
Septembre

STAR WARS  
THE MANDALORIAN THE CHILD



75300  
TIE Fighter™ impérial  
A partir de 8 ans

75300



PILOTE DE  
CHASSEUR TIE



N1-L8



STORMTROOPER™

75301



R2-D2™



PRINCESSE LEIA™



GÉNÉRAL  
DODONNA™



LUKE SKYWALKER™



# STAR WARS

40  
THE  
EMPIRE  
STRIKES BACK



75288  
AT-AT™

A partir de 10 ans



75281  
L'intercepteur Jedi™  
d'Anakin  
A partir de 7 ans



FUSIL À  
RESSORT



75283  
Char d'assaut blindé (AAT™)  
A partir de 7 ans

75281



R2-D2™  
ANAKIN  
SKYWALKER™

75283



DROÏDE  
DE COMBAT  
PILOTE D'AAT, SUPER  
DROÏDE DE COMBAT  
AHSOKA  
TANO™  
CLONE TROOPER  
D'AHSOKA

75288



LUKE  
SKYWALKER™  
GÉNÉRAL VEERS™  
PILOTE  
D'AT-AT  
PILOTE  
D'AT-AT  
SNOWTROOPER™  
SNOWTROOPER™

À RETROUVER DANS



75302  
La Navette impériale  
A partir de 9 ans



75284  
Vaisseau de transport des  
Chevaliers de Ren™  
A partir de 9 ans



75257  
Faucon Millenium™  
A partir de 9 ans



75257



75284



75302



Téléchargez  
LE CATALOGUE 3D

7+  
Ans

LEGO® STAR WARS™

**LEGO****TECHNIC****PULL  
BACK**

42090  
Le pick-up d'évasion  
A partir de 7 ans



42118  
Monster Jam®  
Grave Digger®  
A partir de 7 ans



©2021 Feld Motor Sports, Inc.  
MONSTER JAM®, GRAVE DIGGER®, MAXIMUM DESTRUCTION®, MAX-D®,  
and all related logos and characters/designs are intellectual property  
of and used under license from Feld Motor Sports, Inc. All rights reserved.



42106  
Le spectacle  
de cascades  
du camion et  
de la moto  
A partir de  
8 ans



42119  
Monster Jam® Max-D®  
A partir de 7 ans





42121  
Pelleteuse  
A partir de 8 ans



42120  
Aéroglysieur  
de sauvetage  
A partir de 8 ans



42128  
Le camion de  
remorquage lourd  
A partir de 11 ans



FONCTIONS  
PNEUMATIQUES



Téléchargez  
LE CATALOGUE 3D

7+  
Ans

LEGO® TECHNIC

NOUVEAUTÉ  
Août



# TECHNIC™



**42124**  
Buggy tout-terrain  
A partir de 10 ans



**42109**  
La voiture de rallye contrôlée  
A partir de 9 ans



BBC logo™ and © BBC 1996. Top Gear logo™ and © BBC 2005. Licensed by BBC Studios.

Piles non incluses

Appareil connecté nécessaire mais non inclus

The Bluetooth® word mark and logos are registered trademarks owned by Bluetooth SIG, Inc. and any use of such marks by LEGO System A/S is under license. Other trademarks and trade names are those of their respective owners.



**LEGO® TECHNIC CONTROL+**  
Vérifier la compatibilité  
[LEGO.com/devicecheck](https://LEGO.com/devicecheck)



# VOLVO

The Volvo trademarks (word and device) are registered trademarks of Volvo Trademark Holding AB and are used pursuant to a license.



**42114**  
Le tombereau articulé Volvo 6x6  
A partir de 11 ans



**42129**  
Le camion d'essai 4x4 Mercedes-Benz Zetros  
A partir de 12 ans



"Mercedes-Benz",  and the design of the enclosed product are subject to intellectual property protection owned by Daimler AG. They are used by The LEGO Group under license.

**NOUVEAUTÉ**  
Août



COMMANDE PRINCIPALE



COMMANDE ALTERNATIVE



DÉFIS ET RÉALISATIONS



LEGO® TECHNIC™  
**CONTROL+**



Téléchargez  
LE CATALOGUE 3D

9+  
Ans

LEGO® TECHNIC



# TECHNIC™



**42123**  
**McLaren Senna GTR™**  
A partir de 10 ans



Manufactured under license from McLaren Automotive Limited. The McLaren name and logo are registered trademarks of McLaren. Senna is the registered trademark of Ayrton Senna Empreendimentos Ltda.



**42096**  
**Porsche 911 RSR**  
A partir de 10 ans



**PORSCHE**

Under license of Porsche AG.





Ducati Motor Holding S.p.A. official licensed product.



42107  
Ducati Panigale V4 R  
A partir de 10 ans



42111  
La Dodge Charger de Dom  
A partir de 10 ans



Téléchargez  
LE CATALOGUE 3D

10+  
Ans

LEGO® TECHNICAL

**FAST & FURIOUS** DODGE

© Universal City Studios LLC. All Rights Reserved.  
Dodge and related logos, vehicle model names and trade dress are trademarks  
of FCA US LLC and used under license by The LEGO Group. ©2021 FCA US LLC.



# TECHNIC™

## Jeep

42122  
Jeep® Wrangler  
A partir de 9 ans

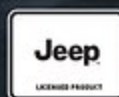

Jeep, the Jeep grille and related logos, vehicle model names and trade dress are trademarks of FCA US LLC and used under license by the LEGO Group. ©2021 FCA US LLC.

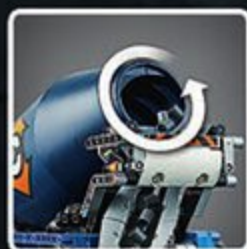

42112  
Le camion bétonnière  
A partir de 10 ans



42110  
Land Rover Defender  
A partir de 11 ans



Land Rover and the Land Rover logo are trademarks owned and licensed by Jaguar Land Rover Ltd.



**NOUVEAUTÉ**  
Octobre

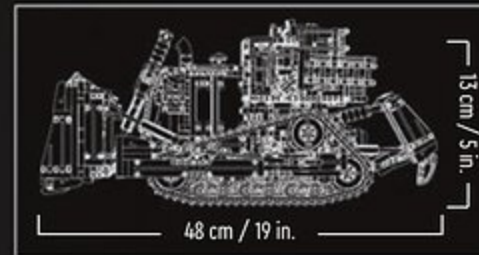

**42131**  
Bulldozer D11 Cat®  
A partir de 18 ans



LEGO® TECHNIC™  
**CONTROL+**



**42125**  
Ferrari 488 GTE  
"AF Corse #51"  
A partir de 18 ans

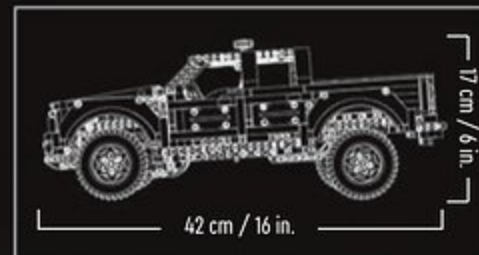

**42126**  
Ford F-150 Raptor  
A partir de 18 ans

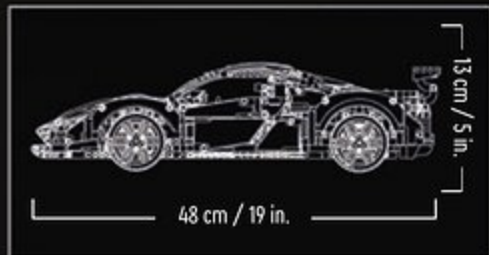

**NOUVEAUTÉ**  
Octobre



Téléchargez  
LE CATALOGUE 3D

**18+**  
Ans

LEGO® SETS POUR ADULTES



©2021 Caterpillar. All Rights Reserved. CAT, CATERPILLAR, LET'S DO THE WORK, their respective logos, "Caterpillar Yellow", the "Power Edge" and Cat "Modern Hex" trade dress as well as corporate and product identity used herein, are trademarks of Caterpillar and may not be used without permission. The LEGO Group, a licensee of Caterpillar Inc.

The Bluetooth® word mark and logos are registered trademarks owned by Bluetooth SIG, Inc. and any use of such marks by LEGO System A/S is under license. Other trademarks and trade names are those of their respective owners.



Ford Trademarks and Trade Dress used under license to The LEGO Group of companies.



Produced under license of Ferrari Spa. The name FERRARI, the PRANCING HORSE device, all associated logos and distinctive designs are property of Ferrari Spa. The body designs of the Ferrari cars are protected as Ferrari Spa property under design, trademark and trade dress regulations.

**BATMAN**

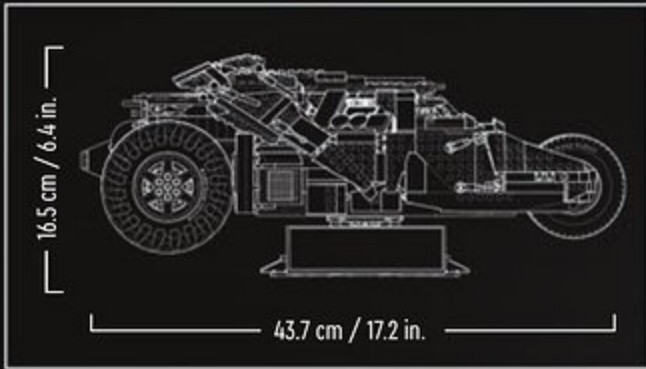

**NOUVEAUTÉ**  
**Novembre**



**76240**  
**La Batmobile™ Tumbler**  
**A partir de 18 ans**



**76182**  
**Le masque**  
**de Batman™**  
**A partir de 18 ans**



BATMAN and all related characters and elements © & ™ DC Comics.  
THE DARK KNIGHT and all related characters and elements © & ™  
DC Comics and Warner Bros. Entertainment Inc.  
WB SHIELD: © & ™ WBEI. (s21)

Célébrez votre passion pour les voyages, les personnages emblématiques et le cinéma avec ces sets LEGO® Art uniques.

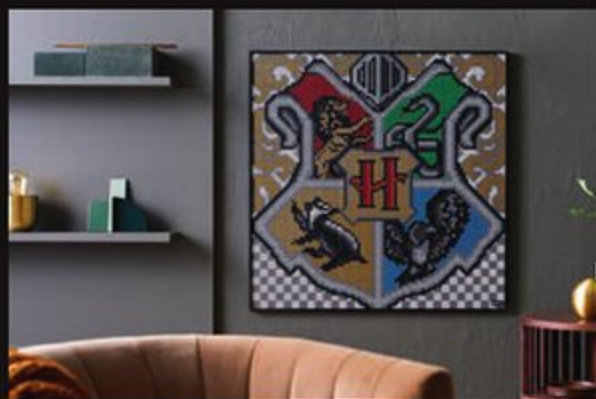

**BANDE-SON**

Disponible uniquement en anglais

# LES SITH

**1 IMAGE  
3 OPTIONS**

LES MODÈLES ILLUSTRÉS  
NE PEUVENT PAS ÊTRE  
CONSTRUITS SIMULTANÉMENT



40 cm / 15.7 in.

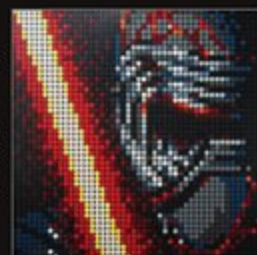

40 cm / 15.7 in.

**STAR WARS**

**31200**  
Star Wars™  
Les Sith™  
A partir de  
18 ans



# HARRY POTTER

**1 IMAGE  
4 OPTIONS**

LES MODÈLES ILLUSTRÉS  
NE PEUVENT PAS ÊTRE  
CONSTRUITS SIMULTANÉMENT

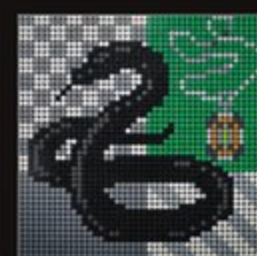
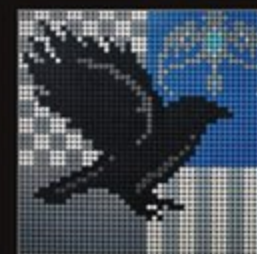

40 cm / 15.7 in.



40 cm / 15.7 in.

**Harry Potter**

**31201**  
Harry Potter™  
Les blasons  
de Poudlard  
A partir de  
18 ans



# MICKEY

MOUSE

**1 IMAGE  
2 OPTIONS**

LES MODÈLES ILLUSTRÉS  
NE PEUVENT PAS ÊTRE  
CONSTRUITS SIMULTANÉMENT

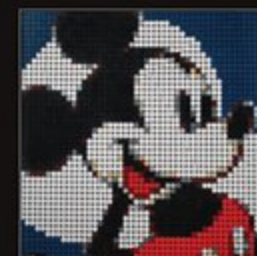
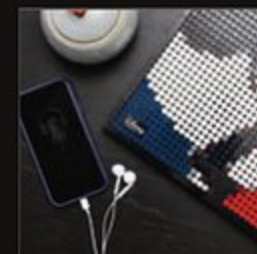
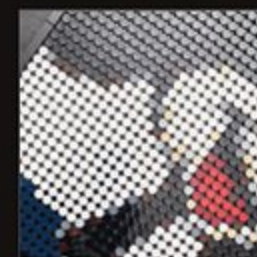

40 cm / 15.7 in.



40 cm / 15.7 in.

**Disney**

**31202**  
Disney's Mickey  
Mouse  
A partir de  
18 ans



Téléchargez  
LE CATALOGUE 3D

18+  
Ans

LEGO® SETS POUR ADULTES

© & ™ Lucasfilm Ltd.



WIZARDING WORLD characters, names and related indicia  
are © & ™ Warner Bros. Entertainment Inc.  
WB SHIELD: © & ™ WBEI. Publishing Rights © JKR. (s21)

©Disney



Vases non inclus



**10280**  
Bouquet de fleurs  
A partir de 18 ans



**10281**  
Bonsaï  
A partir de 18 ans



27 cm / 10.5 in.



**NOUVEAUTÉ**  
Septembre



**10282**  
adidas Originals Superstar  
A partir de 18 ans



**76187**  
Venom  
A partir de 18 ans



**76191**  
Le Gant de l'infini  
A partir de 18 ans

**NOUVEAUTÉ**  
Juin



19 cm / 7 in.



31.9 cm / 12.5 in.

21044  
Paris  
A partir de 12 ans



© Pyramide du Louvre, architecte I. M. Pei, musée du Louvre.

21034  
Londres  
A partir de 12 ans



75276  
Casque de  
Stormtrooper™  
A partir de 18 ans



75304  
Le casque de  
Dark Vador™  
A partir de 18 ans



Téléchargez  
LE CATALOGUE 3D

18+  
Ans

LEGO® SETS POUR ADULTES

Architecture<sup>10</sup>

STAR  
WARS

© & ™ Lucasfilm Ltd.

# Tu AIMES ?

AIDE-NOUS À RENDRE  
LE CATALOGUE LEGO®  
**PLUS COOL**  
POUR TOI !

DEMANDE À UN ADULTE DE  
SCANNER CE CODE OU RENDS-TOI SUR  
[LEGO.COM/ENQUETECATALOGUE](https://www.lego.com/enquetcatalogue)  
POUR RÉPONDRE IMMÉDIATEMENT À  
L'ENQUÊTE !



LEGO Service Consommateurs  
Tél : 00 800 5346 5555  
ou 0 800 600 412  
Pour nous contacter par e-mail,  
veuillez utiliser l'adresse suivante :  
[www.lego.com/fr-fr/service](https://www.lego.com/fr-fr/service)

Les informations contenues dans cette publication, y compris, mais sans limitation, les textes et les illustrations, sont provisoires et données sous toutes réserves; elles sont exclusivement fournies à titre de référence et peuvent être sujettes à modification sans préavis (par exemple en raison d'erreurs d'impression ou de modifications de conditionnement).  
©2021 The LEGO Group. All rights reserved.

Apple and the Apple logo are trademarks of Apple Inc.  
Google Play and the Google Play logo are trademarks of Google LLC.  
Subject to stock availability



Agissez pour  
le recyclage des  
papiers avec  
LEGO SAS  
et Ecofolio.

LEGO, the LEGO logo, the Minifigure, the Brick and Knob configurations, DUPLO, NINJAGO, the FRIENDS logo, the MINIFIGURES logo and MINDSTORMS are trademarks of the LEGO Group. ©2021 The LEGO Group.. 6381939 FR - Holiday Batch

